

Wavelength Allocation in an Optical Switch with a Fiber Delay Line Buffer and Limited-Range Wavelength Conversion

Juan F. Pérez Benny Van Houdt*

Performance Analysis of Telecommunication Systems Research Group,
Department of Mathematics and Computer Science,
University of Antwerp - IBBT,
Middelheimlaan, 1, B-2020 Antwerp, Belgium.
email: {juanfernando.perez, benny.vanhoudt}@ua.ac.be

Abstract

This paper presents an approach to evaluate the performance of an optical switch equipped with both limited-range wavelength conversion and Fiber Delay Lines to resolve contention. We propose an analytical model that allows a general behavior for the packet size distribution while the inter-arrival times are assumed to be of Phase-Type and can easily be relaxed to be generally distributed if needed. As the set of reachable wavelengths is a major issue in limited-range wavelength conversion, we first focus on a simple wavelength set configuration that allows the comparison of different policies and their effect on the loss rate of the system. In addition, a linear association between the loss rate of the simple and a more complex set configuration is identified. Using this association and the results from the analytical model, we derive an approximation for the more complex case, where the interactions among adjacent wavelengths play an important role. The approximation works well for different parameter instances and is particularly useful for the mid load case, when simulations become computationally prohibitive.

1 Introduction

Optical fibers are able to transmit a huge amount of traffic using Wavelength Division Multiplexing (WDM) as it allows a single fiber to carry several signals in different wavelengths. In contrast electromagnetic switches require opto-electronic translations that generate additional delays turning these devices into the bottleneck of the network. Packet switching technologies, such as Optical Burst Switching (OBS) [14, 19], have been introduced to avoid these translations by processing the main part of the signal in the optical domain. As contention may arise in this domain, two alternatives have been proposed: wavelength conversion and optical buffering. The former is done through wavelength converters that allow a packet to be transmitted via a different wavelength than the one it used to enter the switch. A converter may be equipped with full or limited-range wavelength conversion depending on whether it is able to translate a signal to any wavelength or to a restricted subset of them. On the other

*This work has been supported by the FWO-Flanders through project “Stochastic modeling of optical buffers and switching systems based on Fiber Delay Lines” (G.0538.07).

hand optical buffering is implemented using a set of Fiber Delay Lines (FDL) that delay an incoming packet for a specific amount of time proportional to the length of the fiber.

The effect of wavelength conversion without buffering was studied in [1], while the behavior of FDLs in a switch without converters, i.e., in a single wavelength switch, was treated in [8, 9, 20]. Introducing FDLs in a multi-wavelength switch drastically increases the complexity of the system and its analysis. Hence, simulation models have been used to analyze the interaction of both solutions for the case of full range wavelength conversion [3, 4, 6]. An approximation based on an analytical model with a Round-Robin discipline, that relies on the solution of a single wavelength system, is presented in [16]. It is shown to work reasonably well for a fixed packet size when the minimum horizon allocation policy is used. However, the approximations are very poor for other policies and packet lengths. Furthermore, limited-range wavelength conversion usually implies a more intricate interaction between adjacent wavelengths. This topic has been considered in [2, 5, 13] for the bufferless case relying on (approximate) analytical models. More precisely, for exponential packet sizes, the lack of buffers allows an exact solution for the full range conversion case. This result is used to approximate the performance of the limited-range system. With the exception of the aforementioned approximation in [16], no other analytical models including both buffering and wavelength conversion have been developed so far.

In this work we focus on the performance analysis of an optical switch that uses both limited-range wavelength conversion and FDLs to resolve contention. The inclusion of FDLs allows the switch to delay those packets that cannot be transmitted immediately. Given the restriction in the wavelength range in which an incoming packet can be converted, even a few FDLs help to significantly reduce packet losses by exploiting the time domain. This will become clear from the numerical results presented in Sections 4 and 5. In order to study the performance of this system, we propose an analytical model that allows a general behavior for the packet size distribution, while the inter-arrival times are assumed to be of Phase-Type, a class of distributions that allows a wide variety of behaviors. As indicated in Section 3.5, this assumption can be relaxed to allow for general inter-arrival times. In our model the whole set of wavelengths is partitioned in smaller subsets that can be analyzed separately. With this simpler configuration we study the effect of different wavelength allocation policies on the packet loss rate. With the results from the model we propose an approximation for the complex limited-range system. The approximation is based on a linear association we found among the number of losses in the simpler and the more complex systems. This approach works well for different configurations and is particularly useful for the mid load case, when simulations become computationally expensive.

This paper is organized as follows: in Section 2 we present the general configuration of the switch and the different wavelength allocation policies; Section 3 describes the analytical model for the simpler case, while Section 4 reports several results about the effect of the policies and other parameters in the performance of the switch. Section 5 presents the approximation for the more complex case as well as results related to its behavior. Finally we draw some conclusions in Section 6.

2 Optical switch

The optical switch analyzed in this work has a set of K input and output ports, as shown in Figure 1. Packets arrive and leave the switch through any of the W wavelengths in each port.

A set of converters is attached to each input port, while each output port has its own set of FDLs, in a similar fashion as the space switch described in [12, Chapter 10]. We assume the switch has a synchronous operation, making the switching matrix design simpler [4]. Nevertheless, this kind of operation requires packet synchronization and alignment, increasing the complexity of its implementation [1, 4]. On the other hand, an asynchronous switch does not require synchronization nor alignment, but its switching matrix is more complex. A common assumption in slotted synchronous networks is that the packet size is fixed and equal to the time slot. As explained in [3], this means that a packet with a size larger than the time slot must be divided in segments that fit in a slot, including a header for each segment. If variable packet sizes are however allowed in a synchronous switch, only the first segment requires a header, reducing the amount of header processing, a critical issue in optical switching [3].

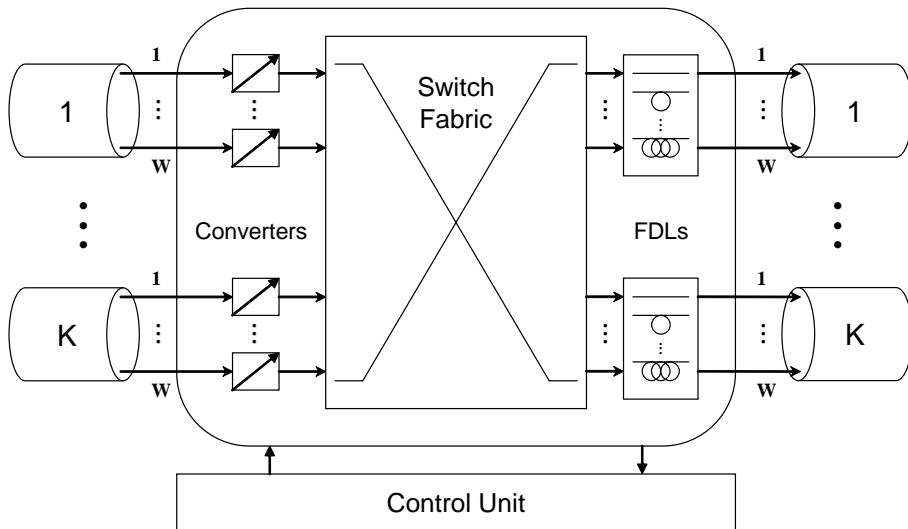

Figure 1: Switch architecture with K input/output fibers, W wavelengths, converters and FDLs

We assume that the traffic destined for each output port is independent from the other ports. Thus we can evaluate the performance of a single port since all of them behave in a similar fashion. When a packet is destined to a specific output port, it comes through one of the W wavelengths (on one of the input ports). If the system provides full-range wavelength conversion, the packet can be converted to any of the other wavelengths without restriction. Nevertheless, wavelength converters can perform slower when trying to convert over a wide range of wavelengths [18]. To avoid this behavior, the converters may be designed to have limited-range wavelength conversion, that is, they are only able to convert to a specific set of output wavelengths [21]. This set is usually made of the home and some adjacent wavelengths [17]. Thus the wavelength allocation problem is to determine the wavelength that the incoming packet must use for transmission among those that are reachable from the home wavelength [3].

The selection of a wavelength for transmission depends on the state of each wavelength in the reachable set. The state of any wavelength can be described by the delay that the arriving packet must face before effective transmission (if it decides to use this particular wavelength

and assuming we had a RAM buffer). Because of the lack of random access memory in the optical domain, FDLs have been proposed to allow buffering for contention resolution. An FDL buffer is made of N fibers, each holding W wavelengths. Each of these fibers allows a particular delay which is a multiple of the basic time slot. We assume that the delays are linearly increasing with granularity D . This means that the first FDL provides a delay equal to D time slots, the second one allows a delay equal to $2D$, while the last FDL delays the packet for ND time slots.

As can be seen, the optical buffer is not able to provide every required delay, but only multiples of the granularity D , a parameter that becomes relevant for buffer design. Furthermore, if the delay required to transmit the incoming packet exceeds ND , the maximum allowable delay, on all wavelengths, the packet must be dropped. Notice, an FDL buffer creates gaps in the channel whenever a packet faces a delay that is not a multiple of D (on the selected wavelength). In this work we do not consider a gap filling strategy as its implementation may be too expensive. These gaps have a relevant influence in the switch performance since the channel will be idle for several intervals even when some packets are waiting for transmission in the FDL. Therefore when a packet is allocated to a particular wavelength, this choice implies both the delay that the packet must face and the gap that it creates on the channel [4].

For the case of limited-range wavelength conversion, the wavelength allocation decision is made over the restricted set of reachable wavelengths. We consider two different alternatives to compose this set:

- Symmetric set: the output set includes the home wavelength and d wavelengths on either side of it [21]. This gives a set of variable size, depending on the position of the home wavelength. For those wavelengths that are at least d positions separated from the first and the last wavelength the set is of size $2d + 1$. For the wavelengths on the borders the output set has a size of $d + 1$ only. In general, if the wavelengths are numbered from 1 to W , where the first and the last are the borders, the output set of wavelength i is

$$\{ \max\{i - d, 1\}, \max\{i - d + 1, 1\}, \dots, i, \dots, \min\{i + d - 1, W\}, \min\{i + d, W\} \},$$

for $i = 1, \dots, W$. The parameter d is called degree of conversion [13].

- Fixed set: in this case the set of wavelengths is partitioned, such that a packet can only be forwarded through the wavelengths that belong to the same partition as its home wavelength. The partition is assumed to be built by adjacent wavelengths since the converters perform faster for a small range of wavelengths.

Once the output set is determined, the selection of the wavelength used for transmission can be made in several ways:

- Random (*Random*): the wavelength used to transmit the packet is selected randomly among those in the output set where the required delay is not greater than ND [13].
- Minimum Horizon (*MinH*): the packet is sent through the wavelength that offers the minimum scheduling horizon, i.e., the one where the delay before transmission is minimum.

- Minimum Gap (*MinGap*): the wavelength selected for transmission is such that the gap created by the scheduling of the packet is minimum among the set of output wavelengths.

The two latter scheduling policies have been studied in [3, 4] for the case of full-range wavelength conversion using simulation models. It must be noted that in those works, as well as here, we assume that whenever a conversion is required, a converter will be available to perform it. The case when there are fewer converters than wavelengths has been studied in [1, 6] assuming full-range wavelength conversion and in [2, 5, 13] for the bufferless limited range wavelength conversion case. In the next section we present a model for the analysis of the case where the set of wavelengths is fixed and the wavelength is selected using the *MinH* or *MinGap* policies.

3 Analytical model for two wavelengths

In this section we assume that the W wavelengths are partitioned in $\frac{W}{2}$ subsets each of size 2. In principle, the model can be generalized to a partitioning with $\frac{W}{k}$ subsets each of size k , with k being a divisor of W . Nevertheless we will restrict ourselves to the two wavelengths case to limit the computation times. Indeed, the size of the model for realistic parameter values is a key issue since the state space grows exponentially if k is chosen larger than two. Nevertheless, the two wavelength case captures to some extent the benefits of having multiple wavelengths since it includes the effect of the wavelength allocation policy. A first approach to model the system can be made by generalizing the horizon model presented in [9, 20] for the single-wavelength buffer. In this case, each wavelength is represented by the scheduling horizon seen by the incoming packet, that is, the time required until all packets scheduled on this wavelength have left the system. If this horizon is greater than ND , the maximum achievable delay, on all wavelengths, the packet is dropped. Even for the case with two wavelengths this approach becomes problematic in terms of the required computation times for realistic parameter values. Another approach is the one proposed in [15], where the state variable is the waiting time of the last accepted packet, using a modified version of the Lindley equation. Although this method provides a much smaller state space, it is only directly applicable for the single-wavelength system.

In order to keep the model size numerically tractable, we propose a model that mixes the two approaches mentioned above by observing the system only when an incoming packet is accepted. Whenever a packet arrives to the FDL it is accepted for transmission if at least one of the wavelengths is able to delay the packet until this wavelength becomes idle. Thus, the system can be represented with two state variables: W_n , the waiting time of the n -th accepted packet, for $n \geq 1$; and H_n , the value of the scheduling horizon of the wavelength that did not admit the n -th accepted packet at its arrival, for $n \geq 1$. As the FDL only provides delays that are multiples of D , the waiting time W_n only takes values in the set $\{0, D, 2D, \dots, ND\}$. The cardinality of this set is much smaller than that of the scheduling horizon H_n , since this variable can adopt values in the set $\{0, 1, 2, \dots, ND + B_{max} - 1\}$, where B_{max} is the maximum packet size.

For the policies studied later, the sequence $\{\{W_n, H_n\}, n \geq 1\}$ is a Markov chain as will be clear from the evolution equations in each case. With the combination of the waiting time and the scheduling horizon as state variables, the state space is much smaller than keeping track of both horizons as state variables. Moreover the state space of the combined variables is not equal to the cartesian product of the sets described above since many of the possible

combinations are not reachable. In fact the reachable state space highly depends on the wavelength allocation policy. It is important to remark that the same modeling approach can be used for $k > 2$. This representation would require one delay variable and $k - 1$ horizon variables, resulting in a huge state space even for $k = 3$.

The packet arrival process is characterized through two sequences of i.i.d. random variables: $\{T_n, n \geq 1\}$ is the time between the arrival of the n -th packet and the next one; and $\{B_n, n \geq 1\}$ is the size of the n -th packet. In this work we assume that $\{B_n, n \geq 1\}$ follows a general discrete distribution with finite support and $\{T_n, n \geq 1\}$ follows a discrete Phase-Type (DPH) distribution with parameters $(\boldsymbol{\beta}, \mathbf{S})$, an assumption easily relaxed to admit any general discrete distribution as well (see Section 3.5).

A DPH variable X can be defined as the time until absorption in a Discrete Time Markov Chain with one absorbing state and all others transient [7]. By partitioning the state space leaving the absorbing state apart, the transition matrix \mathbf{P} and the initial probability vector $\boldsymbol{\gamma}$ can be written as

$$\mathbf{P} = \begin{bmatrix} 1 & \mathbf{0} \\ \mathbf{s} & \mathbf{S} \end{bmatrix} \text{ and } \boldsymbol{\gamma} = [\beta_0 \quad \boldsymbol{\beta}].$$

Since the sum of the elements on each row of \mathbf{P} must be equal to one, \mathbf{s} is determined by $\mathbf{s} = \mathbf{1} - \mathbf{S}\mathbf{1}$, where $\mathbf{1}$ is a column vector of appropriate dimension with all its entries equal to one. The same argument applies for the initial distribution to specify β_0 as $\beta_0 = 1 - \boldsymbol{\beta}\mathbf{1}$. Therefore a DPH representing the time until absorption in \mathbf{P} with initial distribution $\boldsymbol{\gamma}$ is completely determined by the parameters $(\boldsymbol{\beta}, \mathbf{S})$. Distributions of this class can represent any probability distribution with finite support on \mathbb{N} and also include many distributions with countable support as special cases, such as the geometric and negative binomial. For a comprehensive treatment of DPH distributions see [11] and [7]. Throughout this paper we assume that $\beta_0 = 0$, meaning we do not allow batch arrivals.

We assume that the incoming wavelengths of the arrivals destined to a tagged output fiber are uniformly distributed among all the wavelengths. Thus the arrival process to a fixed set of two wavelengths is a thinned DPH arrival process, since with probability $\frac{2}{W}$ a packet comes through one of the wavelengths in the set. With this assumption the set of two wavelengths can be analyzed in isolation and the inter-arrival times to it can be described as a sequence of i.i.d. variables $\{I_n, n \geq 1\}$ that follows a DPH distribution with parameters $(\boldsymbol{\alpha}, \mathbf{T})$, with $\boldsymbol{\alpha} = \boldsymbol{\beta}$ and

$$\mathbf{T} = \mathbf{S} + \left(1 - \frac{2}{W}\right) \mathbf{s}\boldsymbol{\beta}.$$

Even though we exploit the flexibility of DPH distributions for the inter-arrival times, it is important to note that the state space size is independent of the number of phases of the DPH variable. This becomes clear in the next subsections where we present the evolution equations of the system, depending on the rule used for the wavelength selection.

3.1 Minimum Horizon policy

When the next packet arrives after the n -th accepted packet, it will find that the horizons of the wavelengths are equal to $[H_n - I_n]^+$ and $[W_n + B_n - I_n]^+$, where $[x]^+$ stands for $\max(x, 0)$. If at least one of these horizons is less than or equal to ND , the packet will be accepted in the wavelength with the minimum horizon value. Thus the waiting time of the arriving packet

will be given by the horizon of the selected wavelength rounded to the smallest multiple of D (larger than or equal to its horizon value). The horizon value of the other wavelength will remain identical. The evolution equations that describe this process are

$$H_{n+1} = \max\{[H_n - I_n]^+, [W_n + B_n - I_n]^+\} \quad (1)$$

$$W_{n+1} = \left\lceil \frac{\min\{[H_n - I_n]^+, [W_n + B_n - I_n]^+\}}{D} \right\rceil D. \quad (2)$$

If the arriving packet sees that both horizons are above ND , the maximum delay capacity of the FDL, the packet must be dropped. In that case the evolution of the system is given by

$$H_{n+1} = \max\{[H_n - \tilde{I}_n]^+, [W_n + B_n - \tilde{I}_n]^+\}$$

$$W_{n+1} = \left\lceil \frac{\min\{[H_n - \tilde{I}_n]^+, [W_n + B_n - \tilde{I}_n]^+\}}{D} \right\rceil D,$$

where \tilde{I}_n is the time until the next accepted packet, which has a different distribution than I_n , as will be explained in subsection 3.3.

3.2 Minimum Gap policy

Under the *MinGap* policy the incoming packet is assigned to the wavelength in which the gap generated by accepting the packet is minimum, in case both wavelengths are able to accept the incoming packet. Let G_n^1 be the gap generated if the packet is accepted by the wavelength that did not accept the last packet, that is given by

$$G_n^1 = \left\lceil \frac{[H_n - I_n]^+}{D} \right\rceil D - [H_n - I_n]^+.$$

Equivalently, let G_n^2 be the gap generated if the packet is accepted by the wavelength used by the previous accepted packet, that is

$$G_n^2 = \left\lceil \frac{[W_n + B_n - I_n]^+}{D} \right\rceil D - [W_n + B_n - I_n]^+.$$

If $G_n^1 < G_n^2$ then the packet will be sent to the wavelength that did not receive the last packet, causing the new values of the state variables to be

$$H_{n+1} = [W_n + B_n - I_n]^+$$

$$W_{n+1} = \left\lceil \frac{[H_n - I_n]^+}{D} \right\rceil D.$$

If $G_n^1 > G_n^2$ the packet will be sent to the wavelength that was also used by the previous accepted packet, making the variables evolve as

$$H_{n+1} = [H_n - I_n]^+$$

$$W_{n+1} = \left\lceil \frac{[W_n + B_n - I_n]^+}{D} \right\rceil D.$$

In case both potential gaps have the same value or if only one of the wavelengths is able to receive the packet, the evolution follows Equations (1) and (2). If the next arriving packet has to be dropped due to the value of the horizons (both above ND) the evolution will follow the same equations already shown in this section, but using variable \tilde{I}_n instead of I_n to describe the time until the next accepted packet. The distribution of this variable is addressed in the next subsection.

3.3 Distribution of the time until the next accepted packet

As was defined above, the inter-arrival times I_n can be described by i.i.d. DPH variables with parameters (α, \mathbf{T}) . This implies that the arrival process is a DPH renewal process with renewal density $r(\cdot)$ given by

$$r(k) = \alpha(\mathbf{T} + t\alpha)^{k-1}\mathbf{t}, \quad k \geq 1. \quad (3)$$

The density $r(k)$ gives the probability of having an arrival at slot $n+k$ given an arrival in slot n (either with or without arrivals in between). When the system is in state (W_n, H_n) it may not be able to accept a packet arriving in the next time slot, i.e., $\min\{H_n, W_n + B_n\} - 1 > ND$, in which case we use a different inter-arrival distribution to take into account the period of time in which the channel is unavailable. For this we first define $K_n = \min\{H_n, W_n + B_n\} - ND - 1$ as the number of slots required by the system to have a horizon equal to ND after the arrival of the n -th accepted packet. Using this quantity and Equation (3) we can define the probability distribution of the time until the arrival of the next accepted packet \tilde{I}_n as

$$P(\tilde{I}_n = k) = \alpha(\mathbf{T} + t\alpha)^{K_n-1}\mathbf{T}^{k-K_n}\mathbf{t}, \quad k \geq K_n.$$

In this expression the arrival process restarts after the arrival of the last admitted packet. A new phase is selected with probability mass α . Then the system enters an unavailability period of length $K_n - 1$ where every arriving packet is dropped. This period is followed by $k - K_n$ slots without arrivals, after which the arrival process goes to absorption generating an arrival in the next time slot.

3.4 Loss rate

As the model only keeps track of the accepted packets, the loss rate (LR) can be computed from the expected number of losses generated when a new packet is accepted. The expected losses generated by the last admitted packet is computed as a weighted sum of the expected loss in each state with the stationary probability distribution as the weights. In a state where $W_n = W$, $H_n = H$ and the last accepted packet was of size B , the expected number of losses is equal to the expected number of arrivals in a time interval of length $[\min\{W + B, H\} - ND - 1]^+$. This value represents the number of time slots required by the FDL before it is able to accept a new packet.

The expected number of arrivals (A) in a time interval of length L , denoted by $E[A|L]$, depends on the inter-arrival distribution. For the case of geometric inter-arrival times with parameter p , the expected number of arrivals is the expected value of a binomial distribution with parameters p and L : pL . For the case of DPH inter-arrival times, we make use of the renewal density $r(k)$, defined in Equation (3). As $r(k)$ is the probability of an arrival at slot

k for $k \geq 1$, the expected number of arrivals in an interval of length L can be computed as

$$E[A|L] = \sum_{l=1}^L r(l) = \sum_{l=1}^L \boldsymbol{\alpha}(\mathbf{T} + \mathbf{t}\boldsymbol{\alpha})^{l-1} \mathbf{t} = \boldsymbol{\alpha}(\mathbf{I} - (\mathbf{T} + \mathbf{t}\boldsymbol{\alpha})^L)(\mathbf{I} - (\mathbf{T} + \mathbf{t}\boldsymbol{\alpha}))^{-1} \mathbf{t}, \quad (4)$$

where $\boldsymbol{\alpha}$ and \mathbf{T} are the parameters of the DPH distribution.

Let π_{ij} be the stationary probability distribution that an arbitrary accepted packet had to wait i time slots and the scheduling horizon of the wavelength that did not admit that packet is equal to j , for all possible combinations (i, j) in the state space Ω . Also let Ξ be the support of the sequence $\{B_n, n \geq 1\}$, and b_k be the probability mass at point k , for $k \in \Xi$. Then the expected number of losses generated by the last accepted packet is given by

$$\begin{aligned} E[Loss] &= \sum_{(i,j) \in \Omega} \pi_{ij} \sum_{k \in \Xi} b_k E[A | [\min\{i+k, j\} - ND - 1]^+] \\ &= \sum_{(i,j) \in \Omega} \pi_{ij} \sum_{k \in \Xi} b_k \sum_{l=1}^{[\min\{i+k, j\} - ND - 1]^+} \boldsymbol{\alpha}(\mathbf{T} + \mathbf{t}\boldsymbol{\alpha})^{l-1} \mathbf{t}. \end{aligned}$$

Finally, as every accepted packet generates on average a number of losses equal to $E[Loss]$, the loss rate of the system is given by

$$LR = \frac{E[Loss]}{E[Loss] + 1}.$$

3.5 General inter-arrival times

The case of general inter-arrival times can be dealt with in the same way as described above for the DPH case. Let f be the probability mass function of the inter-arrival times. By conditioning on the last arrival before slot k , the renewal density can be defined as

$$r(k) = f(k) + \sum_{j=1}^{k-1} f(j)r(k-j), \quad k \geq 1. \quad (5)$$

This function can be recursively evaluated for any finite k starting with $r(1) = f(1)$. Using the renewal density, the distribution of the time until the arrival of the next accepted packet is given by

$$P(\tilde{I}_n = k) = f(k) + \sum_{j=1}^{K_n-1} f(k-j)r(j), \quad k \geq K_n.$$

This expression accounts for an unavailability period of length $K_n - 1$, after which the next packet arrives at time k . Finally the computation of the LR only requires the determination of the expected value of arrivals in an interval of arbitrary length L , defined above as $E[A|L]$. This can be done in a similar way as in Equation (4), by simply summing the values of the density: $E[A|L] = \sum_{l=1}^L r(l)$. Using this setting it is possible to deal with general inter-arrival times. However, from a practical point of view, the general process offers little additional value, as the DPH class includes any general distribution with finite support.

4 Comparison among policies

In this section we present several results about the performance of the switch with a fixed output set, the size of which is 2 wavelengths. This configuration allows numerical tractability of the model described in the previous section while giving insight about the behavior of the switch under different policies. Here we compare the three policies introduced in Section 2: *Random*, *MinH* and *MinGap*. The comparison is always done in terms of the LR as a function of the granularity, since the former is the main measure of performance and the latter is the most critical design parameter for the FDL buffer. Regarding the other parameters, all the results are for a switch with 32 wavelengths with a load ranging from 50% to 80%. The number of FDLs varies from 1 to 7, since the length of the longest fiber must be kept short enough to be implementable. For the packet size we use three different distributions: the first one assumes a fixed packet size equal to 30 slots; the second has two equiprobable values: 10 and 50 slots; and the third one is a uniform distribution between 20 and 40 slots. We use two different inter-arrival distributions for the comparisons: one is the simple geometric distribution, while the other is a mixture of geometric distributions. The probability mass function of a geometric random variable X with parameter p is given by

$$P(X = k) = (1 - p)^{k-1}p, \quad k \in \{1, 2, \dots\},$$

while the one of a random variable Y representing the mixture of two geometric variables with parameters p_1 and p_2 is given by

$$P(Y = k) = \alpha_1(1 - p_1)^{k-1}p_1 + \alpha_2(1 - p_2)^{k-1}p_2, \quad k \in \{1, 2, \dots\},$$

where α_1 and α_2 are the mixing probabilities. We use this distribution to analyze the case of highly variable inter-arrival times by setting the squared coefficient of variation (SCV) equal to 5.

It should be clear that the set of possible combinations of parameter values is too large to be presented exhaustively. Therefore we concentrate separately on the effect of each of these parameters on the performance of the switch. In Figure 2 we show the switch LR under the three policies, fixing the number of FDLs equal to 5 and varying the load from 50% to 80%. In Figure 3 the load is equal to 60%, while the number of FDLs increases from 1 to 7. In both cases the inter-arrival times follow a geometric distribution. From the figures the performance gain obtained by using *MinH* or *MinGap* over the *Random* policy is evident. Although the output set is made only of 2 wavelengths, the use of the information about the state of the buffer results in a significant reduction in the number of losses. In particular, *MinGap* shows a consistent better performance than the other policies, and the optimal granularity is close to the value of the packet size. The difference among the minimum LRs reached by the policies diminishes as the load increases, but the optimal granularity is more robust for the *MinGap* policy than for the others. Therefore this policy attains the minimum LR over a broad range of loads with the same granularity. From Figure 3 the effect of the number of FDLs becomes clear. In all cases, *MinH* and *MinGap* outperform the simpler *Random* policy, but the differences become more evident as the number of FDLs increases. Particularly the *MinGap* policy realizes an important performance difference since it better exploits the buffering resources, while an increasing number of FDLs implies a larger set of alternatives for buffering.

Similar results for the case of a highly variable arrival process can be seen in Figure 4. Also in this case, when the load increases the shapes of the curves change and the optimal

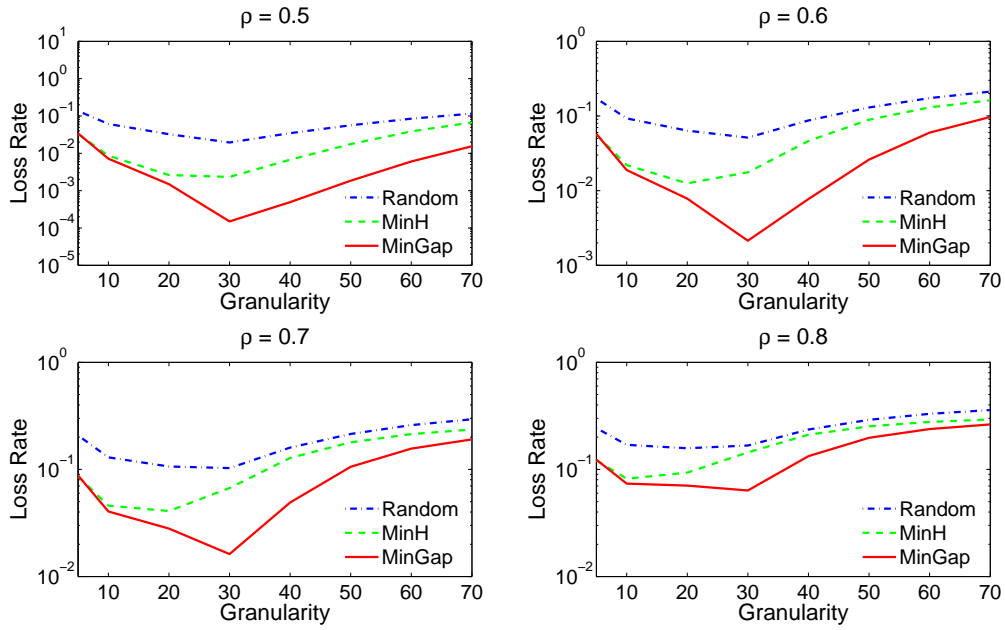

Figure 2: Loss Rate for Fixed Output Set with $W = 32$, $B = 30$, $N = 5$ and geometric arrivals

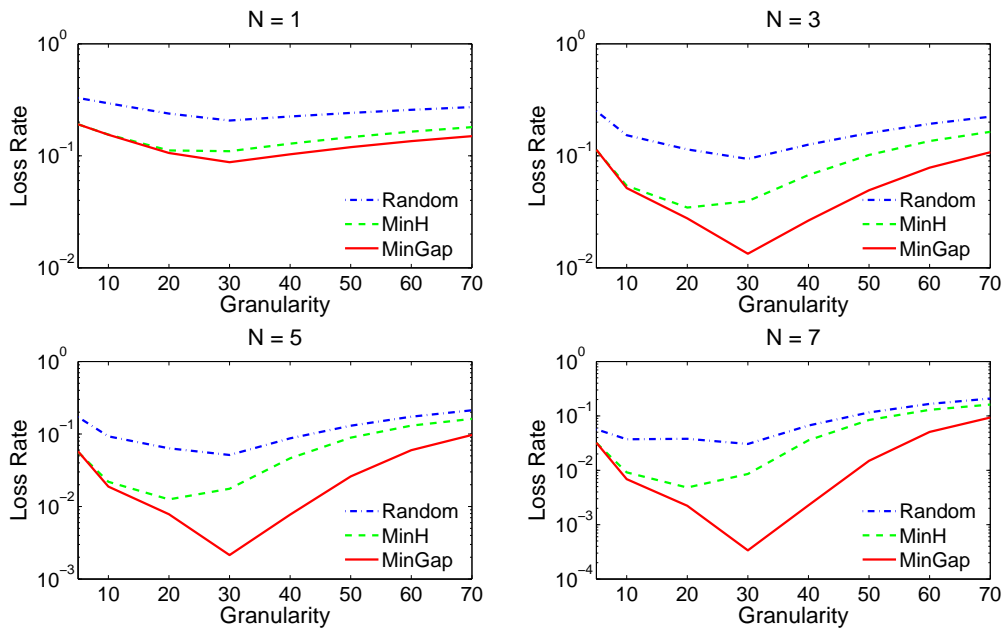

Figure 3: Loss Rate for Fixed Output Set with $W = 32$, $B = 30$, $\rho = 0.6$ and geometric arrivals

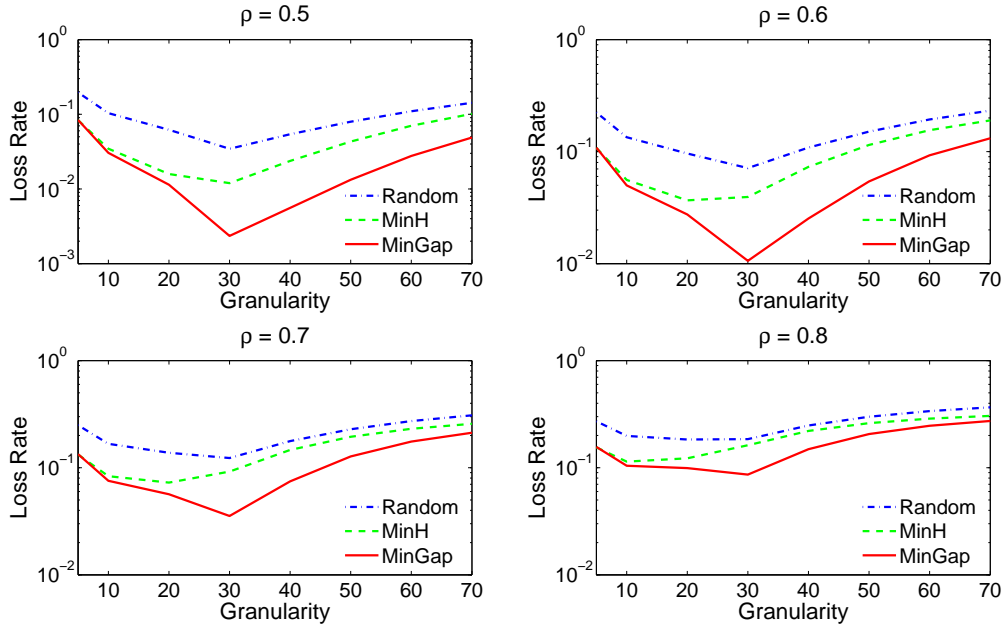

Figure 4: Loss Rate for Fixed Output Set with $W = 32$, $B = 30$, $N = 5$ and inter-arrival times with SCV equal to 5

granularity diminishes in value. Again the *MinGap* policy shows the best performance and the most robust behavior in relation to the optimal granularity. When comparing these results with those in Figure 2 it is clear that the curves keep the same shape, but the losses are larger in the more variable case. For mid loads the difference becomes as large as one order of magnitude, implying an important effect of the arrival process variability. However the difference between the geometric and the high variable cases narrows as the load increases. This means that for high loads the effect of the inter-arrival SCV is not as important as for the mid load case.

In Figure 5 we fix both the load and the number of FDLs in order to focus on the effect of the packet size distribution and the variability of the arrival process. Irrespective of the packet size distribution, higher variability causes an increase in the losses while the optimal granularity remains in the same region. For all the scenarios the *MinGap* policy outperforms the other ones, but the difference is smaller when the arrival process shows high variability. When the packet size can take values 10 or 50 with equal probability, the optimal granularity is located around the larger value, but there is a whole region with a LR close to the optimal. If the packet size follows a uniform distribution between 20 and 40, the optimal granularity is around the expected value. Also in this case there is a set of possible values for the granularity with a performance close to optimal. As the value of the optimal granularity diminishes as the load increases, this parameter can be chosen such that it performs almost optimally for both mid and high loads.

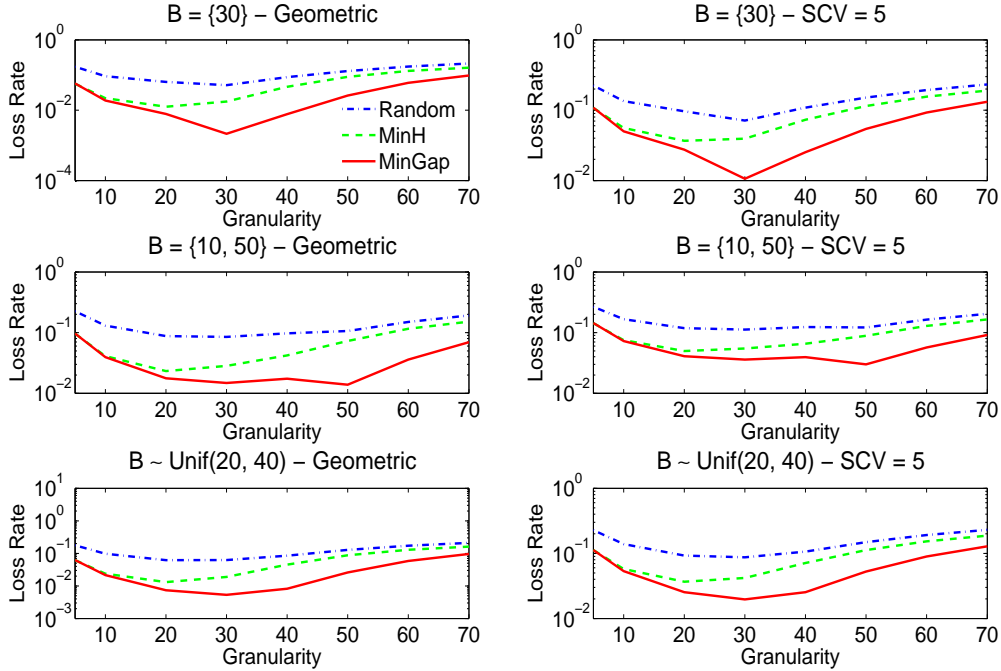

Figure 5: Loss Rate for Fixed Output Set with $W = 32$, $N = 5$ and $\rho = 0.6$

5 An Approximation for the Symmetric Set

As was described in Section 2, the set of reachable wavelengths in the *symmetric* case is made of the adjacent wavelengths and the home wavelength itself. This configuration is particularly difficult to model analytically since the set of servers (output wavelengths) overlaps for the different queues (input wavelengths) in the system. Therefore it is not possible to isolate a set of servers and queues, as was done for the fixed set case, since a set of servers is affected by the queues of the adjacent servers. Furthermore the packets entering through the first and last wavelengths have less alternatives since the output set is smaller than for the central wavelengths. In order to analyze this system we performed several simulations focused on the *MinGap* policy since this policy performs the best among those already analyzed. The estimates of the LR were computed using the batch means method [10] and removing the effect of initial conditions by ignoring the warm-up period. The confidence intervals half width is at most 2% of the mean. These simulations become very expensive when the LR is very small, since the number of events required to compute a good estimate can be computationally prohibitive.

When comparing the results of the simulation for the symmetric system and the analytic model for the fixed output set, we found that the behavior(shape) of the LR as a function of the granularity is similar. This holds in particular for the fixed case with output sets of two wavelengths and the symmetric case with $d = 1$, for many different configurations. As expected, the symmetric case outperforms the fixed one by far in terms of the LR. More specifically, we found a strong linear association between the natural logarithm of the LR for the fixed case and its symmetric counterpart. This is illustrated in Figure 6 where each point is the combination of the logarithm of the LR for the fixed case and the same value for the

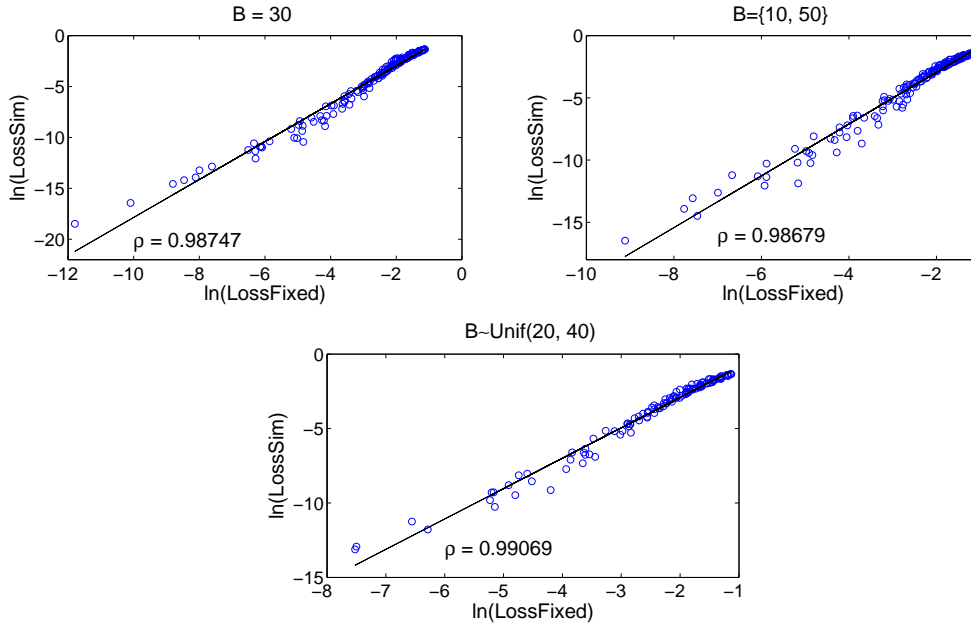

Figure 6: Linear relation between the logarithms of the Loss Rates of the Symmetric ($d = 1$) and the Fixed output sets

symmetric case. The results are separated according to the packet size distribution and the scenarios include different values for the granularity (between 5 and 70), the number of FDLs (from 1 to 5), the load (between 50% and 90%) and the SCV of the arrival process (geometric case and SCV equal to 5). We include in each figure the coefficient of linear correlation, which is very high in all cases.

This behavior suggest an approximation based on both the analytical model and on simulations, which we can apply for the parameters range mentioned above. Let LR_f and LR_s be the loss rate for the fixed and the symmetric cases, respectively. Then we can approximate the loss rate in the symmetric case using the relation $LR_s = \exp\{\beta_0 + \beta_1 \ln(LR_f)\}$. Given a specific configuration (number of FDLs, load, inter-arrival and packet size distribution) we propose to simulate the switch for the symmetric case for two different values of the granularity and to estimate the loss rate as follows. We use the logarithms of the LRs for these two cases (say y_1 and y_2) and compute the same results for the fixed case (x_1 and x_2) to estimate the parameters β_0 and β_1 of the approximate linear equation that relates these two quantities. These are given by

$$\beta_1 = \frac{y_1 - y_2}{x_1 - x_2}, \quad \beta_0 = y_1 - \beta_1 x_1.$$

Hence we can approximate the LR for the symmetric case using the LR for the fixed case obtained with the analytic model and the estimated linear equation. It must be noted that the values of the granularity for the simulations are selected such that the LR estimates for the symmetric case can be computed fast. Even though the simulations are necessary for the proposed approximation, the time required to compute the approximated LR for the symmetric case is significantly smaller than simulating the system for each possible value of

the granularity. Furthermore this last option may be infeasible when the LR becomes very small.

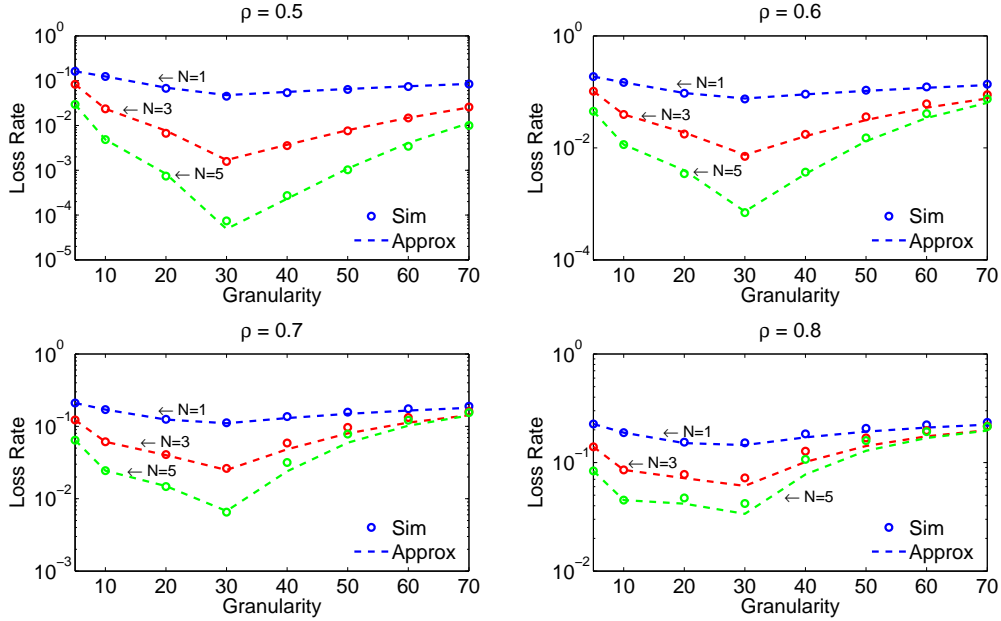

Figure 7: Approximation and simulation of the symmetric output set for $W = 32$, $B = 30$ and inter-arrival times with SCV equal to 5

Figures 7, 8 and 9 show the results of this approximation, one for each packet size distribution considered in Section 4. All the results in these figures assume an inter-arrival time distribution with SCV equal to 5, but similar results were obtained for other coefficients of variation and for the geometric case. To approximate the linear line that relates the logarithms of the LRs we use the results of the simulation when the granularity is equal to 5 and 10, since for these values a good estimate of the LR can be obtained fast. As can be seen in Figure 7, the approximation works adequately for the different configurations shown. The approximation is closer to the actual value for the case of mid loads and a small number of FDLs. It must be noted that the approximation is especially useful for the mid load case to avoid prohibitive simulation times to compute a very small LR. For the case of high loads the approximation becomes somewhat optimistic, a result that holds for the different packet size distributions, as well as for larger loads than those shown in this paper.

Among the different configurations we tried, those with a higher variability in the packet size distribution show the worst performance of the approximation. This is the case in Figure 8, where for loads 50% and 60% the approximation follows the shape of the simulated LR but around its minimum value the loss is overestimated. For the fixed and uniformly distributed packet size, not only the shape of the approximation and the simulation agree but also the values of the approximated LR are very close to those obtained through simulations. Even though this approximation requires to setup and run simulations, the parameters can be chosen such that reliable estimates of the LR can be computed in a short run. The method proposed here can then be used to approximate the value of the LR for those parameter values for which simulation may be unfeasible. Additionally we have found that the linear relation

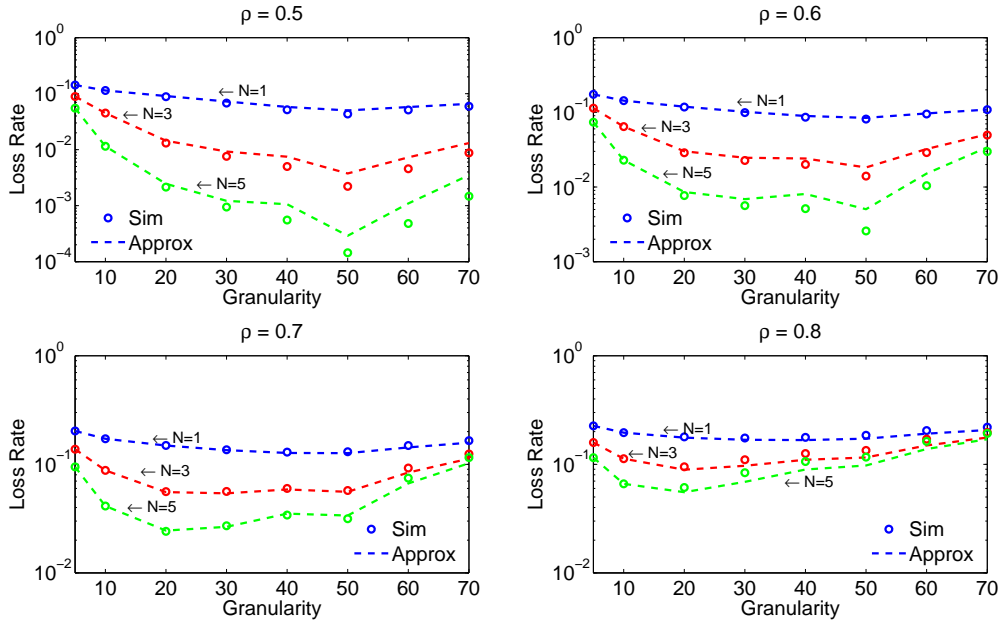

Figure 8: Approximation and simulation of the symmetric output set for $W = 32$, $B = \{10, 50\}$ and inter-arrival times with SCV equal to 5

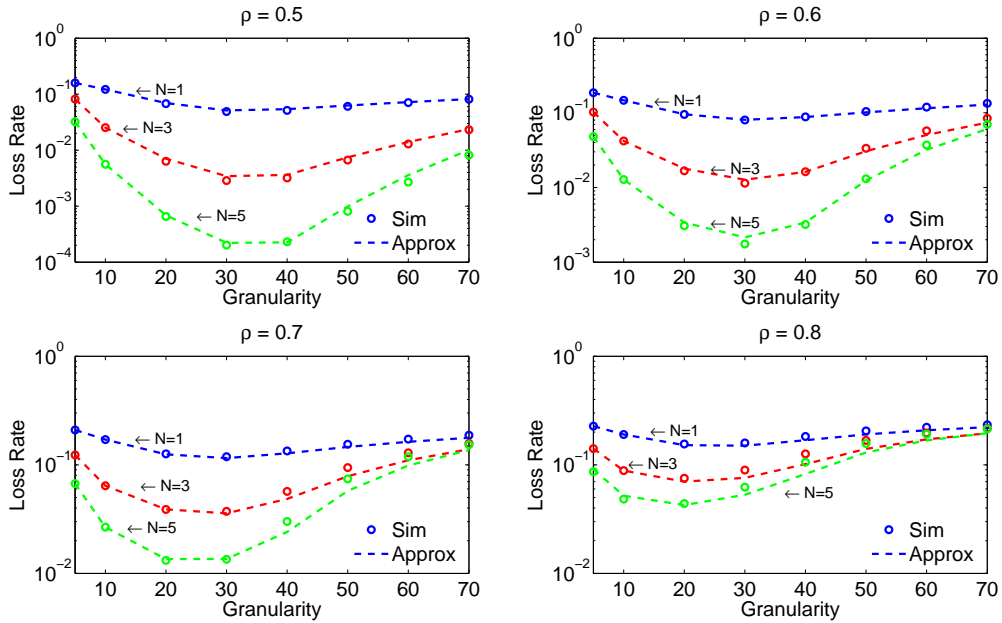

Figure 9: Approximation and simulation of the symmetric output set for $W = 32$, $B \sim Unif(20, 40)$ and inter-arrival times with SCV equal to 5

that supports this approximation also holds between the LRs of the fixed output set and the symmetric one with $d = 2$, as can be seen in Figure 10. Even though the linear correlation is smaller in this case, the approach introduced here can still provide a good approximation for the LR in the symmetric case. Extensions to this work may include a better description of this relation for higher degrees of conversion.

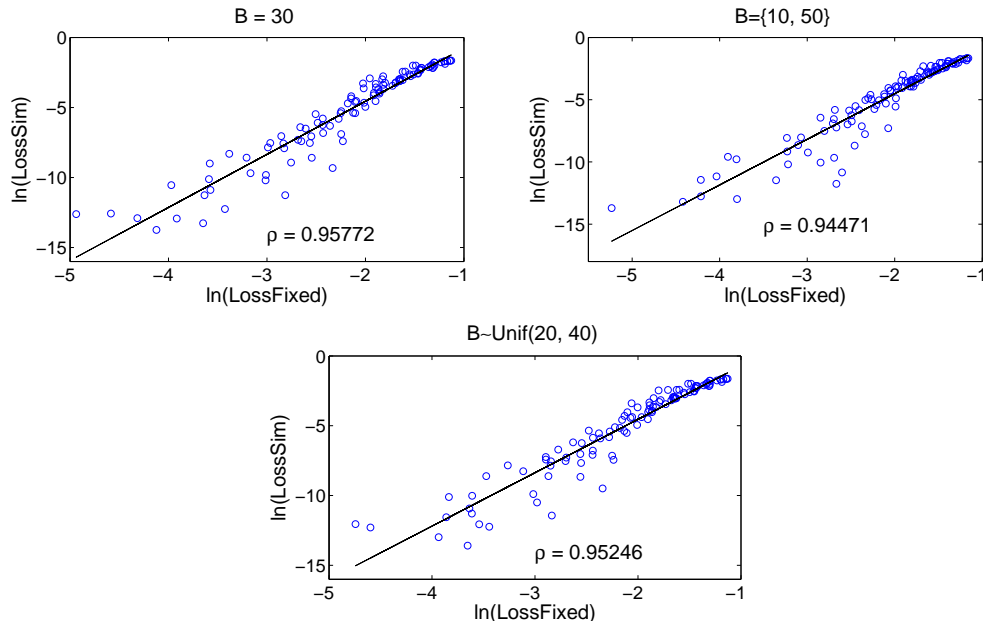

Figure 10: Linear relation between the logarithms of the Loss Rates of the Symmetric ($d = 2$) and the Fixed output sets

6 Conclusions

In this paper we present an analytical model to evaluate the performance of an optical switch equipped with FDL buffers dedicated to each output port and limited range wavelength conversion. The model is particularly well suited for the case of a small fixed output set. The model allows the inclusion of a general arrival process as the inter-arrival times are assumed to follow a DPH distribution. The packet size distribution is assumed to be generally distributed. The model is limited by the state space size to be numerically tractable, but captures the dynamics that wavelength conversion offers.

With this model we study the impact of different policies in the performance of the switch. In particular, we compared the case when the *MinH* and the *MinGap* policies are implemented instead of the *Random* decision rule. Despite the limited-range conversion, we found that any of the first policies outperforms the latter for all the different configurations tried. Furthermore we found that the *MinGap* policy makes better use of the buffering resources as it performs better than *MinH* and this difference becomes larger as the number of FDLs increases. In general, *MinGap* shows a more stable behavior of the optimal granularity, while for the others this value changes rapidly with the load. When the load increases, the differences between the policies are smaller, but *MinGap* still performs better than *MinH*.

We then proposed an approximation for the symmetric output set based on the analytical model for the fixed case. As the symmetric setting is much harder to examine analytically, our approximation makes use of the linear association between the logarithms of the LRs of the fixed and the symmetric setups. Results for the latter were obtained using simulation. The linear equation for a particular configuration of the parameters is approximated by selecting two different granularities and computing the LR for the fixed and the symmetric output sets. With this equation and the results for the fixed case the LR for the symmetric case can be approximated. The results for different values of the parameters show that the approximation behaves adequately. It works particularly well for the case of mid loads and low variability of the packet size.

References

- [1] N. Akar, E. Karasan, and K. Dogan. Wavelength converter sharing in asynchronous optical packet/burst switching: an exact blocking analysis for markovian arrivals. *IEEE Journal on Selected Areas in Communications*, 24:69–80, 2006.
- [2] N. Akar, E. Karasan, G. Muretto, and C. Raffaelli. Performance analysis of an optical packet switch employing full/limited range share per node wavelength conversion. In *Proceedings of IEEE Globecom 2007*, 2007.
- [3] F. Callegati, W. Cerroni, G. Corazza, C. Develder, M. Pickavet, and P. Demeester. Scheduling algorithms for a slotted packet switch with either fixed or variable lengths packets. *Photonic Network Communications*, 8:163–176, 2004.
- [4] F. Callegati, W. Cerroni, C. Rafaelli, and P. Zaffoni. Wavelength and time domain exploitation for QoS management in optical packet switches. *Computer Networks*, 44:569–582, 2004.
- [5] K. Dogan, Y. Gunulay, and N. Akar. A comparative study of limited range wavelength conversion policies for asynchronous optical packet switching. *Journal of Optical Networking*, 6:134–145, 2007.
- [6] C. M. Gauger. Optimized combination of converter pools and FDL buffers for contention resolution in optical burst switching. *Photonic Network Communications*, 8:139–148, 2004.
- [7] G. Latouche and V. Ramaswami. *Introduction to Matrix Analytic Methods in Stochastic Modeling*. ASA-SIAM Series on Statistics and Applied Probability. SIAM, Philadelphia, PA, 1999.
- [8] K. Laevens, M. Moeneclaey, and H. Bruneel. Queuing analysis of a single-wavelength fiber-delay-line buffer. *Telecommunication Systems*, 31:259–287, 2006.
- [9] J. Lambert, B. Van Houdt, and C. Blondia. Queues with correlated inter-arrival and service times and its application to optical buffers. *Stochastic Models*, 22(2):233–251, 2006.
- [10] A. W. Law and W. D. Kelton. *Simulation modeling and analysis*. McGraw-Hill, third edition, 2000.

- [11] M. F. Neuts. *Matrix-Geometric Solutions in Stochastic Models*. The John Hopkins University Press, Baltimore, 1981.
- [12] H. Perros. *Connection-oriented Networks: SONET/SDH, ATM, MPLS and Optical Networks*. John Wiley, 2005.
- [13] V. Puttasubbapa and H. Perros. Performance analysis of limited-range wavelength conversion in an OBS switch. *Telecommunication Systems*, 31:227–246, 2006.
- [14] J. Qiao and M. Yoo. Optical burst switching: A new paradigm for an optical Internet. *Journal of High-Speed Networks*, 8:69–84, 1999.
- [15] W. Rogiest, D. Fiems, K. Laevens, and H. Bruneel. Tracing an optical buffers performance: an effective approach. In *Proceedings of the First Euro-FGI International Conference on Network Control and Optimization, NET-COOP 2007*, 2007.
- [16] W. Rogiest, K. Laevens, D. Fiems, and H. Bruneel. Quantifying the impact of wavelength conversion on the performance of fiber delay line buffers. In *Proceedings of the Sixth International Workshop on Optical Burst/Package Switching, WOBS 2006*, 2006.
- [17] V. Sharma and E. Varvarigos. Limited wavelength translation in all-optical WDM mesh networks. In *Proceedings of the IEEE Infocom'98*, 1998.
- [18] G. Shen, S. Bose, T. Cheng, C. Lu, and T. Chai. Performance study on a WDM packet switch with limited-range wavelength converters. *IEEE Communications Letters*, 5(10):432–434, 2001.
- [19] J. Turner. Terabit burst switching. *Journal of High-Speed Networks*, 8:3–16, 1999.
- [20] B. Van Houdt, K. Laevens, J. Lambert, C. Blondia, and H. Bruneel. Channel utilization and loss rate in a single-wavelength Fibre Delay Line (FDL) buffer. In *Proceedings of IEEE Globecom 2004*, 2004.
- [21] J. Yates, J. Lacey, D. Everitt, and M. Summerfield. Limited-range wavelength translation in all-optical networks. In *Proceedings of the IEEE Infocom'96*, 1996.